

Products Covered

256-PLL	256-PLD	256-PAS
256-PAQ	256-PAT	256-PAR

Introduction

Models 256-PLL, 256PLD

Paralleling Protector modules provide manual/automatic switching of generator to busbar.

The volt free relay contacts change state when voltage, phase relationship and frequency are within the selected synchronising limits.

Models 256-PAS, 256-PAT, 256-PAQ, 256-PAR

Reverse Power Protectors monitor the current and power factor of a.c generators connected in parallel with another generator or with the a.c mains and give an alarm or control signal should power flow into the generator (i.e. reverse power) exceed a user-adjusted level.

Model 256-PAQ and 256-PAR have a push to test button.

Warning

- During normal operation, voltages hazardous to life may be present at some of the terminals of this unit. Installation and servicing should be performed only by qualified, properly trained personnel' abiding by local regulations. Ensure all supplies are de-energised before attempting connection or other procedures.
- It is recommended adjustments be made with the supplies de-energised, but if this is not possible, then extreme caution should be exercised.
- Terminals should not be user accessible after installation and external installation provisions must be sufficient to prevent hazards under fault conditions.
- This unit is not intended to function as part of a system providing the sole means of fault protection - good engineering practice dictates that any critical function be protected by at least two independent and diverse means.
- Never open circuit the secondary winding of an energised current transformer.

Installation

The Protector should be installed in a dry position, not in direct sunlight and where the ambient temperature is reasonably stable and will not be outside the range 0-60 degrees Celsius. Mounting will normally be on a vertical surface but other positions will not affect the operation and vibration should be kept to a minimum. The Protectors are designed for mounting on a 35mm rail to DIN 46277. Alternatively they may be screw fixed.

To mount a protector on a DIN rail, the top edge of the cut-out on the back is hooked over one edge of the rail and the bottom edge carrying the release clip clicked into place. Check that the unit is firmly fixed. Removal or repositioning may be achieved by levering down the release clip and lifting the unit up and off the rail.

Electromagnetic Compatibility

This unit has been designed to provide protection against EM (electromagnetic) interference in line with requirements of EU and other regulations. Precautions necessary to provide proper operation of this and adjacent equipment will be installation dependent and so the following can only be general guidance:-

- Avoid routing wiring to this unit alongside cables and products that are, or could be, a source of interference.
- The auxiliary supply to the unit should not be subject to excessive interference. In some cases, a supply line filter may be required.

Protector Trip Relays
DIN Rail & Wall Mounted 250 Series
Paralleling & Reverse Power

- To protect the product against incorrect operation or permanent damage, surge transients must be controlled. It is good EMC practice to suppress differential surges to 2kV or less at the source. The unit has been designed to automatically recover from typical transients, however in extreme circumstances it may be necessary to temporarily disconnect the auxiliary supply for a period of greater than 5 seconds to restore correct operation.
- Screened communication and small signal leads are recommended and may be required. These and other connecting leads may require the fitting of RF suppression components, such as ferrite absorbers, line filters etc., if RF fields cause problems.
- It is good practice to install sensitive electronic instruments that are performing critical functions in EMC enclosures that protect against electrical interference causing a disturbance in function.

Fusing and connections

1. This unit must be fitted with external fuses in voltage and auxiliary supply lines.
2. Voltage input lines must be fused with a quick blow fuse 1A maximum.
3. Auxiliary supply lines must be fused with a slow blow fuse rated 1A maximum.
4. Choose fuses of a type and with a breaking capacity appropriate to the supply and in accordance with local regulations.
5. Where fitted, CT secondaries must be grounded in accordance with local regulations.

Screw torque

Main terminal screws should be tightened to 1.35Nm or 1.0 ft/lbf only. Detachable terminal connector screws should be tightened to 0.9Nm or 0.7 ft/lbf only. Where fitted, terminal covers are held in place by miniature self tapping screws into plastic. These screws should be tightened by hand only, sufficiently to secure the terminal cover and prevent it vibrating.

Setting Up

Model 256-PLL

The module is connected to monitor voltage values from both busbar and incoming generator systems. The generator supply powers the electronics and the relay. The input signals are compared for voltage level and phase relationship and when the resultant is below the selected limit a command signal energises the relay. A time delay ensures frequencies are virtually equal at synchronising.

Model 256-PLD

This operates in the same way as the type 256-PLL, with the addition of the "Dead Bus" facility. This extra feature enables the relay to energise with a generator supply only. Thus the 256-PLD will allow the generator to power the busbar during mains failure.

Models 256-PLL and 256-PLD

The front mounted, calibrated control should be set to suit operational requirements. A red LED on the front indicates, when lit, that the output relay is in the energised state.

Models 256-PAS, 256-PAT, 256-PAQ & 256-PAR

All reverse power units have front mounted, calibrated controls and these should be set to suit operational requirements. A red LED on the front indicates, when lit, that the output relay is in the energised state. The output relay is normally arranged to energise on trip. Note, this means that it is necessary to know whether the output relay is arranged to energise or de-energise on trip before the tripped or untripped state of a Protector can be determined from the condition of the LED. The working range is power factors between 0.5 inductive / Unity / 0.25 Capacitive



**Protector Trip Relays
DIN Rail & Wall Mounted 250 Series
Paralleling & Reverse Power**

All Models

The calibration marks around the controls are provided as a guide if the installer does not have access to accurate equipment. The maximum error of the calibration marks is typically 10% of the span of the control concerned.

Maintenance

The unit should be inspected to normal standards for this class of equipment. For example remove accumulations of dust and check all connections for tightness and corrosion. In the unlikely event of a repair being necessary it is recommended that the unit be returned to the factory or to the nearest Crompton Instruments Service Centre.

Connection diagrams

Connection diagrams should be carefully followed to ensure correct polarity and phase rotation. External current and voltage transformers may be used to extend the range.

Models 256-PAS, 256-PAT, 256-PAQ & 245-PAR

Note: Only one CT connection is required

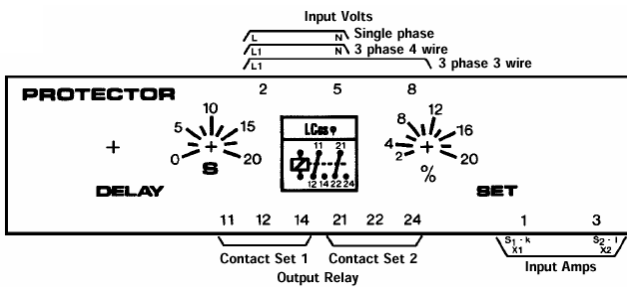

Dimensions

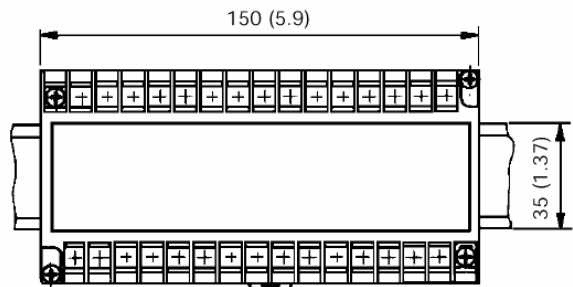

**256-PAS & 256-PAQ
Single Phase or 3 Phase 4 Wire**

**256-PAT & 256-PAR
3 Phase 3 Wire**

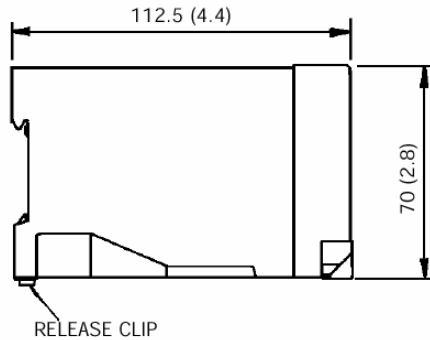
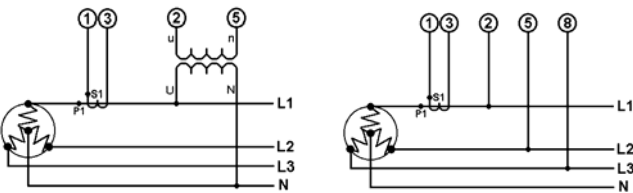

Models 256-PLL & 256-PLD

Note: When systems are in synchronism and within the selected limits contacts 5 & 6 are closed and contacts 7 & 8 are open.

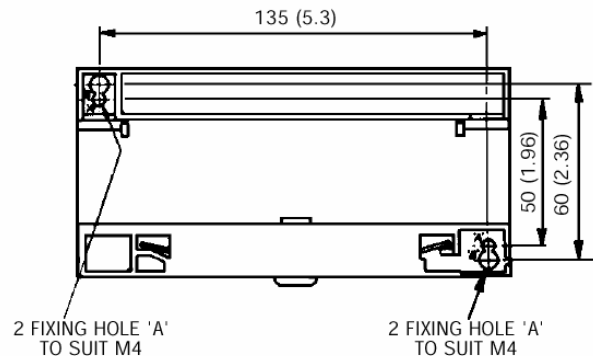
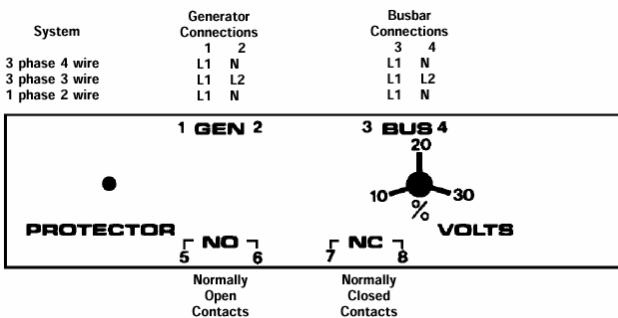

The Information contained in these installation instructions is for use only by installers trained to make electrical power installations and is intended to describe the correct method of installation for this product. However, Tyco Electronics has no control over the field conditions, which influence product installation. It is the user's responsibility to determine the suitability of the installation method in the user's field conditions. Tyco Electronics' only obligations are those in Tyco Electronics' standard Conditions of Sale for this product and in no case will Tyco Electronics be liable for any other incidental, indirect or consequential damages arising from the use or misuse of the products. Crompton is a trade mark.



Models Covered

252-PAO	252-PVH	253-PAV	252-PAU
252-PVJ	253-PAP	252-PBA	252-PVK
253-PBV	252-PBB	252-PVO	253-PHD
252-PBS	252-PVP	253-PVB	252-PBT
252-PVR	253-PVE	252-PHO	252-PVS
253-PVM	252-PHU	252-PVU	253-PAD
252-PTU	252-PVV	252-PTO	252-PVX
256-PHV	252-PVA	252-PVZ	252-PVC

Introduction

Protector Trip relay inputs are monitored within settable limits. In the event of the input moving outside these limits, the unit will initiate a trip signal via a double pole changeover relay.

An illuminated red LED indicates when the relay is energised. Relays normally energise on over or high and de-energise on under or low conditions. This function may be reversed on request when ordering.

Electromagnetic Compatibility (EMC) Installation Requirements

This product range has been designed to meet the certification requirements of the EU Directives when installed to a good code of practice for EMC in industrial environments. e.g.

1. Screen output and low signal input leads. In the event of RF fields causing problems where screened leads can not be used, provision for fitting RF suppression components, such as ferrite absorbers, line filters etc., must be made.
- N.B. It is good practice to install sensitive electronic instruments that are performing critical functions, in EMC enclosures that protect against electrical interference causing a disturbance in function.
2. Avoid routing leads alongside cables and products that are, or could be, a source of interference.
3. To protect the product against permanent damage, surge transients must be limited to 2kV pk.
4. Electro Static Discharge (ESD) precautions must be taken at all times when handling this product.

For assistance on protection requirements please contact your local sales office.

Installation

The Protector should be installed in a dry position, not in direct sunlight and where the ambient temperature is reasonably stable and will not be outside the range 0-60°C. Mounting will normally be on a vertical surface but other positions will not affect the operation and vibration should be kept to a minimum. The Protectors are designed for mounting on a 35mm rail to DIN 46277. Alternatively they may be screw fixed; a special adaptor is supplied to mount 252 types. To mount a protector on a DIN rail, the top edge of the cut-out on the back is hooked over one edge of the rail and the bottom edge carrying the release clip clicked into place. Check that the unit is firmly fixed. (Removal or

**Protector Trip Relays
DIN Rail & Wall Mounted 250 Series
Current, Voltage, Phase Sequence,
Transducer, Millivolt & Thermocouple**

repositioning may be achieved by levering down the release clip and lifting the unit up and off the rail).

These products do not have internal fuses therefore external fuses **must** be used for safety protection under fault conditions.

Earth/Ground Connections

For safety reasons, CT secondary connections should be grounded according to local codes of practice.

Setting Up

All Protectors have front mounted; calibrated controls and these should be set to suit operational requirements. A red LED on the front indicates, when lit, that the output relay is in the energised state. Note, this means that it is necessary to know whether the output relay is arranged to energise or de energise on trip before the tripped or untripped state of a Protector can be determined from the condition of the LED. The calibration marks around the controls are provided as a guide if the installer does not have access to accurate equipment. The maximum error of the calibration marks is typically 10% of the span of the control concerned.

Maintenance

The unit should be inspected to normal standards for this class of equipment. For example remove accumulations of dust and check all connections for tightness and corrosion. In the unlikely event of a repair being necessary it is recommended that the unit be returned to the factory or to the nearest Crompton Instruments Service Centre, (details on page 2). Should repair be attempted then replacement components must be of the same type, rating and tolerance as those used in the original circuit. It is important that should calibration be deemed necessary, say after repair, then this should only be attempted if the required high accuracy equipment is available. With any enquiry please quote the full model number found on the side of the label. The unit must be recalibrated after repair. Side labels show full connection information and data.

Low Voltage Directive: This product complies with BSEN61010-1

Warning

Voltages dangerous to human life may be present at some of the terminals of this unit. Ensure all supplies are de-energised before attempting any connection/disconnection. If it is necessary to make adjustments with the power connected then exercise extreme caution.

This product is manufactured by Crompton Instruments, Freebournes Road, Witham, Essex. England. CM8 3AH. Telephone +44 (0) 1376 509509, Fax: +44 (0) 1376 509511.



INSTALLATION INSTRUCTIONS

Protector Trip Relays DIN Rail & Wall Mounted 250 Series Current, Voltage, Phase Sequence, Transducer, Millivolt & Thermocouple

252-PBA
252-PBB
252-PBS
252-PBT
252-PHO
252-PHU
252-PTO
252-PTU
252-PAO
252-PAU
252-PVH
252-PVO
252-PVU
252-PVZ

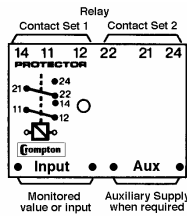

252-PVA
252-PVC
252-PVJ
252-PVK
252-PVP
252-PVS
252-PVV
252-PVX

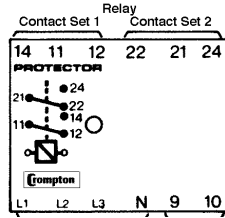

253-PBV
253-PAD

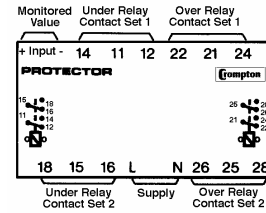

253-PAV
253-PAP

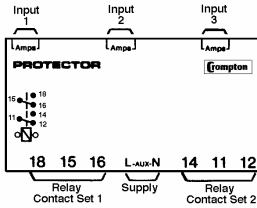

253-PVE
253-PVM

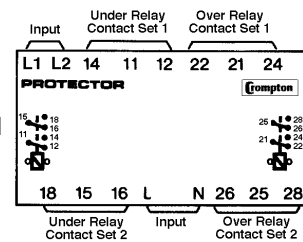
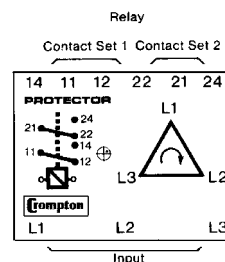

253-PHD
253-PVB

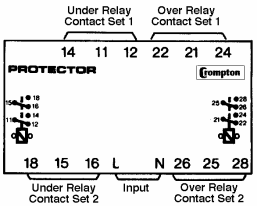

256-PHV

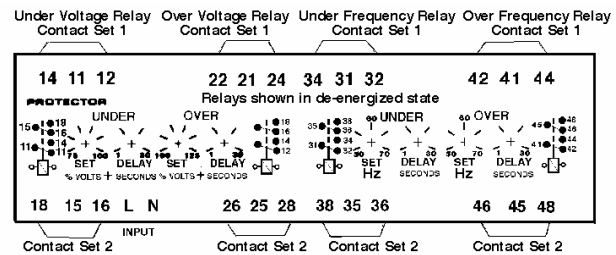

Model 252

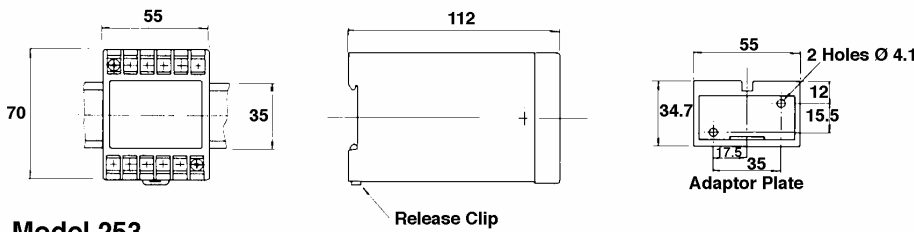

Model 253

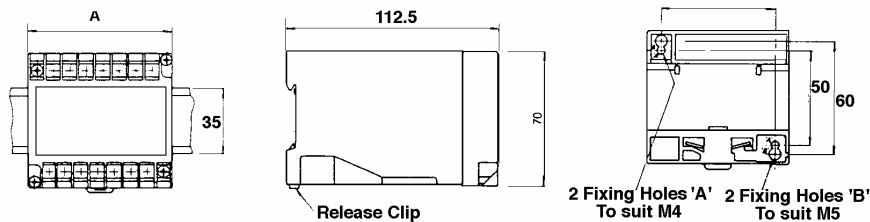

Connection diagrams should be carefully followed to ensure correct polarity and phase rotation. External current and voltage transformers may be used to extend the range. Connection wires should be sized to comply with applicable regulations and codes of practice. These products do not have internal fuses therefore external fuses **must** be used for safety protection under fault conditions.

Model	A	B
253	75	60
256	150	135

The Information contained in these installation instructions is for use only by installers trained to make electrical power installations and is intended to describe the correct method of installation for this product. However, Tyco Electronics has no control over the field conditions, which influence product installation. It is the user's responsibility to determine the suitability of the installation method in the user's field conditions. Tyco Electronics' only obligations are those in Tyco Electronics' standard Conditions of Sale for this product and in no case will Tyco Electronics be liable for any other incidental, indirect or consequential damages arising from the use or misuse of the products. Crompton is a trade mark.



Tyco Electronics UK Limited
Crompton Instruments

Freebournes Road, Witham, Essex, CM8 3AH, UK
Phone: +44 1376 509 509 Fax: +44 1376 509 511

<http://energy.tycoelectronics.com>

Models Covered

252-PMM	252-PMT	252-PSF
252-PSG	253-PH3	252-PMM
252-PMT		

Introduction

Thermistor Trip Relay (252-PMM & 252-PMT)

The trip inputs are monitored within settable limits. In the event of the input moving outside these limits, the unit will initiate a trip signal via a double pole changeover relay. An illuminated green LED indicates when the thermistor temperature is within normal working limits.

The unit is designed such that the alarm relay is energised when normal temperatures are reached.

Model 252-PMM has the facility for manual resetting, so that the trip condition remains after normal operating temperature is reached, until manual intervention occurs.

Installation

The Protector should be installed in a dry position, not in direct sunlight and where the ambient temperature is reasonably stable and will not be outside the range 0 to 60 degrees Celsius. Mounting will normally be on a vertical surface but other positions will not affect the operation and vibrations should be kept to a minimum. The Protectors are designed for mounting on a 35mm rail to DIN 46277. Alternatively they may be screw fixed; a special adaptor is supplied to mount 252 types.

To mount a protector on a DIN rail, the top edge of the cutout on the back is hooked over one edge of the rail and the bottom edge carrying the release clip clicked into place. Check that the unit is firmly fixed. Removal or repositioning may be achieved by levering down the release clip and lifting the unit up and off the rail.

Phase Balance Relay (252-PSF & 252-PSG)

Trip inputs are monitored within settable limits. In the event of the input moving outside these limits, the unit will initiate a trip signal via a double pole changeover relay. An illuminated red LED indicates that the supply is within limits.

Speed Sensing Relay (253-PH3)

Trip inputs are monitored within settable limits. In the event of the input moving outside these limits, the unit will initiate a trip signal. The illuminated red LED's indicates that the single pole output relays are in an energised state and at normal running speed all three relays should be energised. Units are factory adjusted for normal running speed = 0.75mA output. The meter adjust pot on the product front is used for this requirement, which also ensures the trip levels are set to the calibrated values. Terminal 8 is connected to terminal 5 internally. Terminals 15 and 16 give a 0/1mA signal proportional to speed.

- No.1 Relay energises on rising speed
- No.2 Relay energises on rising speed
- No.3 Relay de-energises on rising speed

This product is designed for use only with magnetic coil inductive sensors.

**Protector Trip Relays
DIN Rail & Wall Mounted 250 Series
Thermistor Trip, Speed Sensing &
Phase Angle**

252-PMM, 252-PMT & 253-PH3

Pick up, input and output leads should be kept separate from any other wiring.

Setting Controls (252-PSF, 252-PSG)

These products have two calibration facilities that can be set to suit operating requirements and they are factory calibrated as follows:-

1. % unbalance set points
Voltages of and below 380 volts L-L are calibrated to 1.0% class index of rated voltage. Voltages above 380 volts L-L are calibrated to 1.5% class index of rated voltage.
2. Time Delay
For all voltage ranges 10% maximum delay.
3. Voltage Withstand
Continuous overload = 1.35 x rated voltage

Setting Up (all other models)

The calibration marks around the controls are provided as a guide if the installer does not have access to accurate equipment. The maximum error of the calibration marks is typically 10% of the span of the control concerned.

Maintenance

The unit should be inspected to normal standards for this class of equipment. For example remove accumulations of dust and check all connections for tightness and corrosion. In the unlikely event of a repair being necessary it is recommended that the unit be returned to the factory or to the nearest Crompton Instruments Service Centre, (details on page 2). Should repair be attempted then replacement components must be of the same type, rating and tolerance as those used in the original circuit. It is important that should calibration be deemed necessary, say after repair, then this should only be attempted if the required high accuracy equipment is available. With any enquiry please quote the full model number found on the side label. The unit must be recalibrated after repair.

Electromagnetic Compatibility (EMC) Installation Requirements

This product range has been designed to meet the certification requirements of the EU Directives when installed to a good code of practice for EMC in industrial environments. e.g.

1. Screen output and low signal input leads. In the event of RF fields causing problems where screened leads can not be used, provision for fitting RF suppression components, such as ferrite absorbers, line filters etc., must be made.
- N.B. It is good practice to install sensitive electronic instruments that are performing critical functions, in EMC enclosures that protect against electrical interference causing a disturbance in function.
2. Avoid routing leads alongside cables and products that are, or could be, a source of interference.
3. To protect the product against permanent damage, surge transients must be limited to 2kV pk.
4. Electro Static Discharge (ESD) precautions must be taken at all times when handling this product.



Ref: IW250PMSH – Rev 6 – March 02

Protector Trip Relays DIN Rail & Wall Mounted 250 Series Thermistor Trip, Speed Sensing & Phase Angle

For assistance on protection requirements please contact your local sales office.

Connection Diagrams

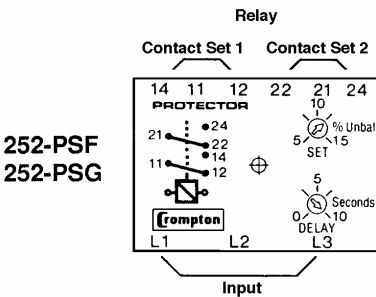
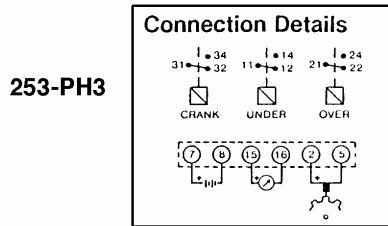
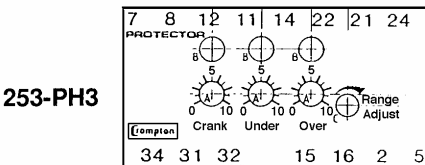
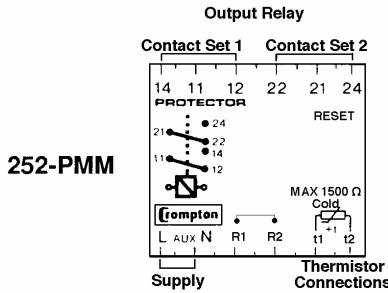
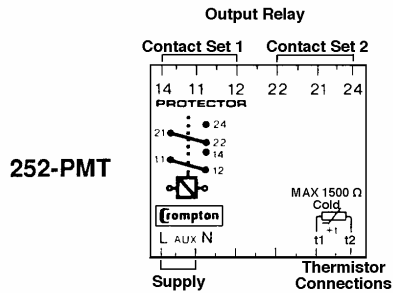

252-PMM can operate in either an automatic or a manual reset mode. For automatic the reset link R1-R2 is to be disconnected. For manual the reset link R1-R2 must be inserted.

Connection diagrams should be carefully followed to ensure correct polarity and phase rotation where applicable. External voltage transformers may be used on 252-PSF and 252-PSG to extend the range. Connection wires should be sized to comply with applicable regulations and codes of practice. These products do not have internal fuses therefore external fuses **must** be used for safety protection under fault conditions.

LOW VOLTAGE DIRECTIVE:- This product complies with BSEN61010-1

WARNING

Voltages dangerous to human life may be present at some of the terminals of this unit. Ensure all supplies are de-energised before attempting any connection/disconnection. If it is necessary to make adjustments with the power connected then exercise extreme caution.

This product is manufactured by Crompton Instruments, Freebournes Road, Witham, Essex. CM8 3AH. Telephone +44 (0) 1376 509509, Fax: +44 (0) 1376 509511.

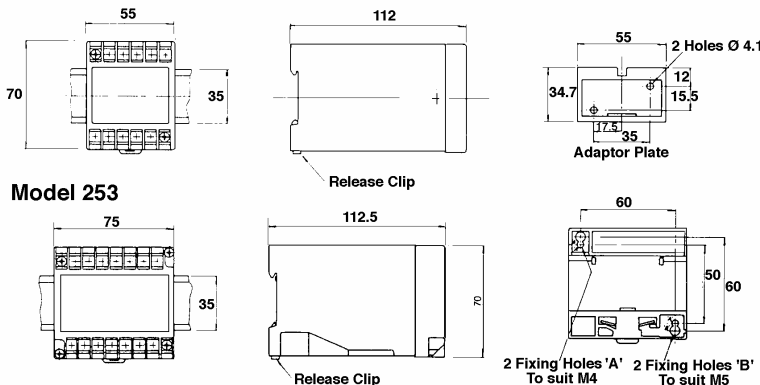

The Information contained in these installation instructions is for use only by installers trained to make electrical power installations and is intended to describe the correct method of installation for this product. However, Tyco Electronics has no control over the field conditions, which influence product installation. It is the user's responsibility to determine the suitability of the installation method in the user's field conditions. Tyco Electronics' only obligations are those in Tyco Electronics' standard Conditions of Sale for this product and in no case will Tyco Electronics be liable for any other incidental, indirect or consequential damages arising from the use or misuse of the products. Crompton is a trade mark.



Tyco Electronics UK Limited
Crompton Instruments

Freebournes Road, Witham, Essex, CM8 3AH, UK
Phone: +44 1376 509 509 Fax: +44 1376 509 511

<http://energy.tycoelectronics.com>

Page 1 of 2

Ref: IW250PRC – Rev 4 – Sept 02

Model	256-PRA	3 RTD inputs	3 set points
	256-PRB	3 RTD inputs	2 set points
	256-PRC	3 RTD inputs	1 set point
	256-PCC	6 RTD inputs	1 set point

Introduction

Hot spot 3 temperature trip relays (256-PRA, 256-PRB and 256-PRC) monitor three temperature zones, using Resistance Temperature Detectors. The highest of three temperatures is automatically selected and a 0 to 1mA signal produced for indication or record purposes. Model 256-PCC accepts up to six inputs from resistance temperature detector (RTD) elements. The temperature trip point, common to all channels, is user adjustable. The outputs are volt free contacts from a single pole changeover relay, with LED indication of normal (green) or tripped (red) conditions. Additional red LED's are fitted to show which of the inputs are exceeding the trip point.

Installation

The Protector should be installed in a dry position, not in direct sunlight and where the ambient temperature is reasonably stable and will not be outside the range 0 to 60 degrees Celsius.

Mounting will normally be on a vertical surface but other positions will not affect the operation and vibration should be kept to a minimum. The Protectors are designed for mounting on a 35mm rail to DIN 46277. To mount a protector on a DIN rail, the top edge of the cut-out on the back is hooked over one edge of the rail and bottom edge carrying the release clip clicked into place. Check that the unit is firmly fixed. Removal or repositioning may be achieved by levering down the release clip and lifting the unit up and off the rail. Input cables must be mounted away from high voltages and heavy current carrying cables and may require screening. Connection diagrams should be carefully followed to ensure correct polarity.

Electromagnetic Compatibility

This unit has been designed to provide protection against EM (electro-magnetic) interference in line with requirements of EU and other regulations. Precautions necessary to provide proper operation of this and adjacent equipment will be installation dependent and so the following can only be general guidance:-

- Avoid routing wiring to this unit alongside cables and products that are, or could be, a source of interference.
- The auxiliary supply to the unit should not be subject to excessive interference. In some cases, a supply line filter may be required.
- To protect the product against incorrect operation or permanent damage, surge transients must be controlled. It is good EMC practice to suppress differential surges to 2kV or less at the source. The unit has been designed to automatically recover from typical transients, however in extreme circumstances it may be necessary to temporarily disconnect the

Protector Trip Relays

DIN Rail & Wall Mounted 250 Series Hot Spot 3 & Hot Spot 6

- auxiliary supply for a period of greater than 5 seconds to restore correct operation.
- Screened communication and small signal leads are recommended and may be required. These and other connecting leads may require the fitting of RF suppression components, such as ferrite absorbers, line filters etc., if RF fields cause problems.
- It is good practice to install sensitive electronic instruments that are performing critical functions in EMC enclosures that protect against electrical interference causing a disturbance in function.

Setting Up The 256-PRA, 256-PRB, 256-PRC

The working temperature range for the 0/1mA output is adjusted before despatch. The set points can be adjusted to any value within this working range. Adjustments are made via screw driver operated 20-turn potentiometer, accessible from the front panel. Turn this control anti-clockwise to raise the trip point, clockwise to lower it. Most products are supplied with the set points pre-set at the required values, If specific instructions were supplied at the time of ordering. Adjustment example: If the working range of the product is 0/100°C, and the set points were pre-set to 50°C, then one clockwise turn of the set point adjuster will lower this setting to 45°C (because 1/20th of 100°C = 5°C).

If any of the three temperature inputs exceed a set point, a relay will trip and a red LED will illuminate to indicate the tripped condition.

Setting Up The 256-PCC

The working temperature range is adjusted before despatch. The set point can be adjusted to any value within this working range. Adjustment can be made via a screw driver operated 20-turn potentiometer, accessible from the front panel. Turn this control anti-clockwise to raise the trip point, clockwise to lower it. Most products are supplied with the set point pre-set at the required value, If specific instructions were supplied at the time of ordering. Adjustment example: If the working range of the product is 0/100°C, and the set point was pre-set to 50°C, then one clockwise turn of the set point adjuster will lower this setting to 45°C (because 1/20th of 100°C = 5°C).

If any of the six temperature inputs exceed the set point, the relay will trip and a red LED will illuminate to indicate the tripped condition.

Maintenance

The unit should be inspected to normal standards for this class of equipment. For example, remove accumulations of dust and check all connections for tightness and corrosion. In the unlikely event of a repair being necessary, it is recommended that the unit be returned to the factory or to the nearest Crompton Instruments Service Centre.



INSTALLATION INSTRUCTIONS

Protector Trip Relays DIN Rail & Wall Mounted 250 Series Hot Spot 3 & Hot Spot 6

Dimensions

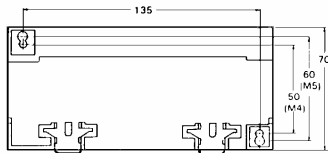
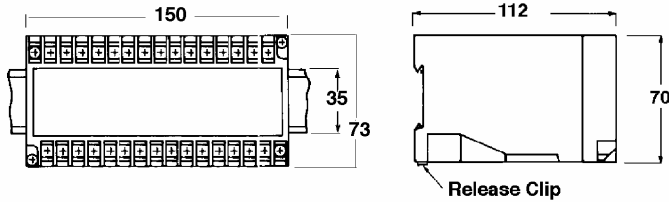

Rear View Showing Panel Mounting Holes

Model 256-PCC

When used for less than 6 RTD inputs the unused terminals 1, 2 & 3 must be linked together.

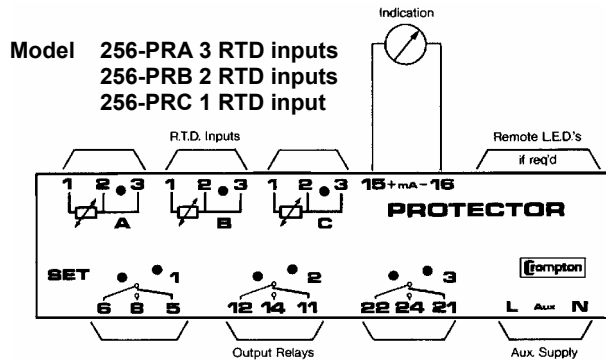
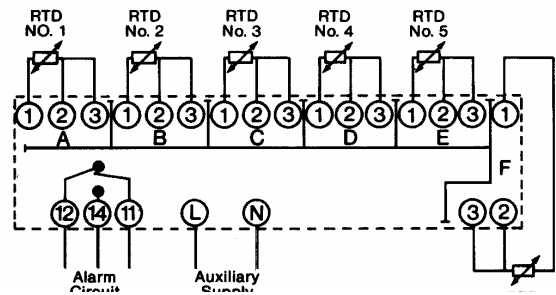

The Information contained in these installation instructions is for use only by installers trained to make electrical power installations and is intended to describe the correct method of installation for this product. However, Tyco Electronics has no control over the field conditions, which influence product installation. It is the user's responsibility to determine the suitability of the installation method in the user's field conditions. Tyco Electronics' only obligations are those in Tyco Electronics' standard Conditions of Sale for this product and in no case will Tyco Electronics be liable for any other incidental, indirect or consequential damages arising from the use or misuse of the products. Crompton is a trade mark.



Tyco Electronics UK Limited
Crompton Instruments

Freebournes Road, Witham, Essex, CM8 3AH, UK
Phone: +44 1376 509 509 Fax: +44 1376 509 511

<http://energy.tycoelectronics.com>