







Energy Division

# Installation and Operating Instructions

## Integra Ci1

The following symbols may appear in this user guide, and may also be affixed to the products discussed in this guide:

| <b>Symbol</b>   | <b>Description</b>                  |
|---|-------------------------------------|
|  | Earth terminal                      |
|  | Protective conductor terminal       |
|  | Caution, Risk of electric shock     |
|  | Caution, Refer to accompanying text |

# Contents

|          |  |           |
|----------|--|-----------|
| <b>1</b> | <b>Introduction</b>                                    | <b>5</b>  |
| 1.1      | Unit Characteristics .....                             | 5         |
| 1.2      | Current Transformer Primary Current .....              | 5         |
| 1.3      | RS485 Serial Option Modbus™ or JC N2Protocol.....      | 5         |
| 1.4      | Pulse Output Option.....                               | 5         |
| <b>2</b> | <b>Start Up Screens</b>                                | <b>6</b>  |
| <b>3</b> | <b>Measurement Mode</b>                                | <b>6</b>  |
| <b>4</b> | <b>Setting-Up</b>                                      | <b>7</b>  |
| 4.1      | Setup Entry Methods .....                              | 8         |
| 4.1.1    | Menu Option Selection.....                             | 8         |
| 4.1.2    | Number Entry Procedure .....                           | 8         |
| 4.2      | Change Password.....                                   | 9         |
| 4.3      | Supply System .....                                    | 9         |
| 4.4      | CT .....   | 10        |
| 4.5      | Reset.....   | 10        |
| 4.6      | Communications .....                                   | 11        |
| 4.7      | Relay Pulse Output.....                                | 13        |
| 4.8      | Energy Units and 1% Limit.....                         | 15        |
| 4.9      | Test.....  | 16        |
| 4.10     | Version Information .....                              | 18        |
| <b>5</b> | <b>Specification</b>                                   | <b>19</b> |
| 5.1      | Measurement Inputs .....                               | 19        |
| 5.1.1    | Range of Use .....                                     | 19        |
| 5.2      | Accuracy .....   | 19        |
| 5.3      | Auxiliary Supply .....                                 | 19        |
| 5.4      | Option Modules.....                                    | 20        |
| 5.4.1    | Pulse Relay Outputs .....                              | 20        |
| 5.4.2    | RS485 Output for Modbus™ or JC N2 Protocol .....       | 20        |
| 5.5      | Reference Conditions of Influence Quantities.....      | 20        |
| 5.6      | Environment.....                                       | 21        |
| 5.7      | Mechanics.....   | 21        |
| 5.8      | Approval, Certification, and Standards Compliance..... | 21        |
| <b>6</b> | <b>Maintenance</b>                                     | <b>22</b> |
| <b>7</b> | <b>Installation</b>                                    | <b>22</b> |
| 7.1      | Safety.....  | 22        |
| 7.2      | EMC Installation Requirements .....                    | 23        |
| 7.3      | Case Dimensions and Panel Cut-Out .....                | 24        |

---

|          |  |           |
|----------|--|-----------|
| 7.4      | Wiring .....   | 25        |
| 7.5      | Additional considerations for three wire systems ..... | 25        |
| 7.6      | Auxiliary Supply .....                                 | 25        |
| 7.7      | Fusing.....  | 25        |
| 7.8      | Earth/Ground Connections.....                          | 25        |
| 7.9      | Connection Diagrams.....                               | 26        |
| 7.10     | RS485 and Modbus™ or JC N2 Protocol.....               | 27        |
| 7.11     | Operation Check .....                                  | 27        |
| <b>8</b> | <b>Glossary</b>  | <b>28</b> |
| <b>9</b> | <b>Index</b>   | <b>29</b> |

**Important safety information is contained in the Maintenance section.  
Familiarise yourself with this information before attempting installation  
or servicing of the unit.**

# 1 Introduction

This document provides operating, maintenance and installation instructions for the Crompton Instruments Integra Ci1 energy meter. The unit displays imported or exported real and reactive energy, since it was last reset, in terms of Wh, kWh, MWh, VARh, kVARh and MVARh for single phase, three-phase 3-wire or three-phase 4-wire supplies. In order to measure energy, the unit requires voltage and current inputs in addition to the supply required to power the unit. The current input(s) are obtained via current transformers (CTs).

The unit can be configured to work with a wide range of CTs, giving the unit a wide range of operation. Option modules can be fitted to provide pulse and RS485 Modbus™/JC N2 outputs. Configuration is password-protected.

The unit can be powered from a separate auxiliary a.c. (or d.c.). Alternatively it can be powered from the monitored supply where appropriate.

## 1.1 Unit Characteristics

- Active Energy (Wh, kWh or MWh)
- Reactive Energy (VARh, kVARh or MVARh)

The unit has password-protected set-up screens for:

- Changing password.
- CT primary current (1 to 9999A)
- Energy reading reset
- Pulse output duration and rate divisor (option)
- RS485 serial Modbus™ or JC N2 format (option)

Pulsed relay outputs, indicating energy, and an RS485 output are available as optional extras. The RS485 output option allows remote monitoring from another display or a computer.

## 1.2 Current Transformer Primary Current

The unit can be configured to operate with CT primary current of between 1 and 9999A. Maximum CT primary current corresponds to a maximum input current to the unit of 5A.



## 1.3 RS485 Serial Option Modbus™ or JC N2 Protocol

This option uses an RS485 serial port with Modbus™ or Johnson Controls (JC) N2 protocol to provide a means of remotely monitoring and controlling the Ci1 unit. Both protocols are supported in the same unit. Full instructions for RS485 port can be found in Section 4.6.

## 1.4 Pulse Output Option

This option provides one or two relay pulse outputs that clock up measured active (Wh) or reactive (VARh) energy. The unit can produce one pulse for preset quantity of energy imported or exported. Pulse rate divisor and width are configured from the Set-up menu, as detailed in Section 4.7.













## 2 Start Up Screens

|   |  |
|---|--|
|  | <p>The first screen lights all LED segments and can be used as a display LED check.</p>                                      |
|  | <p>The second screen indicates the firmware installed in the display unit. This example shows a version number of 10.06.</p> |
|  | <p>Next the unit performs a self-test and the screen indicates if the test is passed.</p>                                    |

After a short delay, the default measurement screen appears.

## 3 Measurement Mode

In measurement mode, the buttons control the displayed measurement as follows:



|   |   |   |
|---|---|---|
|    |    | <p>Displays the maximum current that can be monitored. This reading is set on installation according to the current transformer in use. The small 'A' on the bottom line indicates that the display is showing Amperes.</p>   |
|  |  | <p>Displays active energy measured since the unit was last reset. The display alternates between Imported and Exported energy each time the button is pressed. The bottom line of the display shows the import/export mode and the Wh, kWh or MWh range. The  and/or  symbol on the top line flashes each time an output pulse is generated.</p>                    |
|  |  | <p>Displays reactive energy measured since the unit was last reset. The display alternates between Imported and Exported reactive energy each time the button is pressed. The bottom line of the display shows the import/export mode and the VArh, kVArh or MVarh range. The  and/or  symbol on the top line flashes each time an output pulse is generated.</p> |
|  |  | <p>This display indicates the phase sequences of the measured voltages and currents, allowing a check that they are connected correctly. The sequence can be 123 or 132 but voltage (V) and current (I) sequences must be the same. A 'V1--' or 'I --' display indicates a phase error of voltage or current, respectively.</p>   |



The top line of the display indicates the type of supply being monitored:



The blue man  flashes to indicate that energy for the currently displayed parameter is being accumulated.

## 4 Setting-Up

To enter set-up mode, firmly press the  and  buttons simultaneously and hold for about 5 seconds until the password screen  appears. Setting-up is password-protected so you must enter the correct password (default '0000') before proceeding. If an incorrect password is entered, the display reverts to measurement mode.

To exit setting-up mode, press  repeatedly until the measurement screen is restored or hold  and  buttons simultaneously for 5 seconds.

### Setup Menu Structure

#### **Change password**

*nnnn* 4-digit number – default '0000'

#### **Supply system**

3-phase 4-wire

3-phase 3-wire

single phase

**CT** Set maximum current that can be monitored according to CT in use.

*nnnn* – 4-digit number 0001 to 9999.

**Reset** Resets cumulative energy measurement to zero.

#### **Communication parameters** for RS485 interface

Modbus™ protocol

Baud rate 2400/4800/9600/19200/38400

Parity none/odd/even

Stop bits 1 (1 or 2 if parity is None)

RS485 network address *nnn* – 3-digit number 1 to 247

Order –Norm/Rev Indicates if Modbus™ word order is normal or reversed.

Johnson Controls (JC) N2 protocol

RS485 network address *nnn* – 3-digit number 1 to 255

#### **Relay pulse outputs**

OP1 kWh/kVAh (Active/reactive) Import or Export from output module 1

OP2 kWh/kVAh (Active/reactive) Import or Export from output module 2

Rate 0.001/0.01/0.1/1/10/100/1000/10,000 kWh or kVAh per pulse

Pulse width 200/100/60 ms.

#### **Energy**

Unit/kilo/Mega

1% limit on/off

#### **Test**

Phase sequence (V123 I123)

Display on – all elements on to check display

d1STG Display toggle – Each element is turned on and off alternately.











**SFS** Build number

**SFH** Firmware version

## 4.1 Setup Entry Methods





Some menu items, such as password and CT, require a four-digit number entry while others, such as supply system, require selection from a number of options.

### 4.1.1 Menu Option Selection

1. Use the  (up) and  (down) keys to select the required item from the menu shown in Section 0. Selection does not roll over from bottom to top of list or vice versa.
2. Press  (enter) key to confirm your selection.
3. If an item flashes (shown **red** on these pages), then it can be adjusted by the  and  keys. If not, there may be a further layer, e.g. Comms - Baud rate, before adjustment is possible. Press  to select the lower layer.
4. Having selected an option from the current layer, press  to confirm your selection. The SET indicator will come on.
5. Having completed a parameter setting, press  (back) to return to a higher menu level.  
The SET indicator will extinguish and you can then use the  and  keys for further menu selection.
6. On completion of all setting-up, repeatedly press  to return to the measurement screen.











### 4.1.2 Number Entry Procedure

When setting-up the unit, some screens require the entering of a number. In particular, on entry to the setting-up section, a password must be entered. Digits are set individually, from left to right. The procedure is as follows:

1. The current digit to be set flashes (shown **red** on these pages) and is set using the  and  keys.
2. Press  to confirm each digit setting. The SET indicator comes on to confirm successful entry after the last digit has been set.
3. After setting the last digit, press  to exit the number setting routine. The SET indicator will extinguish.















## 4.2 Change Password

|    |   |   |
|----|---|---|
| 1. | Use  and  to choose the Change Password option.   |  |
| 2. | Press  to enter the change password routine. The New Password screen will appear with the first digit flashing.  |  |
| 3. | Use  and  to set the first digit and press  to confirm your selection. The next digit will flash. |   |
| 4. | Repeat the procedure for the remaining three digits.  |   |
| 5. | After setting the last digit, the SET indicator will light.   |   |
| 6. | Press  to exit the number setting routine and return to the Set-Up menu. The SET indicator will extinguish.  |  |



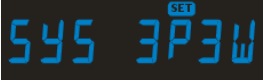

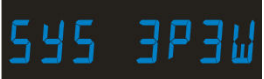

## 4.3 Supply System

Use this section to set the type of power supply being monitored.

|    |   |   |
|----|---|---|
| 1. | From the Set-up menu, use the  and  keys to select the System option. The screen will show the currently selected supply option.  |  |
| 2. | Press  to enter the Supply Selection routine.  |  |
| 3. | Use the  and  keys to select the required system option:<br>  <br><i>3-phase 4-wire</i> <i>3-phase 3-wire</i> <i>single phase</i> |   |
| 4. | Press  to confirm your selection. SET indicator will appear.   |  |
| 5. | Press  to exit the system selection routine and return to the menu. The SET indicator will extinguish and you will be returned to the main Set-Up menu.  |  |









### 4.4 CT

The CT option sets the maximum primary current of the current transformer (CT) that will give 5A into the meter (the maximum).

|    |  |   |
|----|--|---|
| 1. | From the Set-up menu, use the  and  keys to select the CT option. The screen will show the current CT primary current value. An 'A' on the bottom line indicates that the reading is in Amperes. |  |
| 2. | Press  to enter the CT routine. The first digit will flash.   |  |
| 3. | Use the method described in Section 4.1.2 to set the 4-digit number to the maximum CT primary current, e.g. 500A.  |   |
| 4. | On completion of the entry procedure, press  to return to the main Set-up menu.   |  |

### 4.5 Reset



















Use this option to restart energy measurements (kWh, kVArh) from zero.

|    |   |   |
|----|---|---|
| 1. | From the main Setup menu, use the  and  keys to display the Reset screen. |  |
| 2. | Press  . 'hour' will flash.  |  |
| 3. | To reset the energy readings, press  . SET will be displayed and 'hour' will stop flashing.  |  |
| 4. | Press  to exit the Reset routine. SET will extinguish and you will be returned to the main Set-up menu.  |  |







## 4.6 Communications





The RS485 port can be used for communications using either Modbus™ or Johnson Controls (JC) N2 protocol. For Modbus™, parameters such as Baud rate are selected from the front panel whereas for JC N2 they are fixed. The RS485 address can be selected for both protocols.

The first section allows you to select either Modbus™ or JC N2 configuration.

|  |   |   |
|--|---|---|
| 1.   | From the main Setup menu, use the  and  keys to display the Communications screen.         |    |
| 2.   | Press  . The Format screen will appear showing the current format – ModB or N2.  |    |
| 3.   | To change the format, press  . The format will flash.  |    |
| 4.   | Use the  or  key to change the format.  |    |
| 5.   | Press  to confirm your selection. SET will be displayed.  |   |
| 6.   | Press  to exit the format selection routine. The SET indicator will extinguish.  |  |
| <p>If you have selected N2 format, you can use the  or  key to select the RS485 address option and set it as detailed on page 13.</p> <p>If you have selected ModB format, set the serial parameters as follows:</p> |   |   |
| 7.   | Use the  or  key to cycle through the Baud, parity, stop bits and address menu options. |  |















### Baud Rate (not applicable for JC N2)

|     |  |   |
|-----|--|---|
| 8.  | To change the Baud setting, ensure that the display shows the Baud setting and press  to enter the Baud setting routine. The setting digits will flash.   |  |
| 9.  | Use the  and  keys to select the desired Baud rate from the available options 9600, 4800, 2400, 38.4k (38400) and 19.2k (19200). |  |
| 10. | Press  to confirm your Baud rate selection. SET will be displayed.  |  |

|     |   |   |
|-----|---|---|
| 11. | Press  to exit Baud setting routine. The SET indicator will extinguish and the  and  keys can be used to select a different Comms parameter. |  |
|-----|---|---|















**Parity (not applicable for JC N2)**

Note that if parity is set to Odd or Even, Stop Bits will be set to 1 and cannot be changed.

|     |   |   |
|-----|---|---|
| 12. | Use the  and  keys to select the Parity option.   |    |
| 13. | Press  to enter the parity setting routine. The parameter will flash.  |    |
| 14. | Use the  and  keys to select the desired parity option from None, Even and Odd.   |    |
| 15. | Press  to confirm your selection. SET will be displayed.  |   |
| 16. | Press  to exit parity setting routine. The SET indicator will extinguish and the  and  keys can be used to select a different Comms parameter. |  |

**Stop Bits(not applicable for JC N2)**





Note that, if Parity is set to Odd or Even, Stop Bits will be set to 1 and cannot be changed.

|     |  |   |
|-----|--|---|
| 17. | Use the  and  keys to select the Stop Bits option.   |  |
| 18. | Press  to enter the Stop Bits setting routine. The parameter value will flash.  |  |
| 19. | Use the  and  keys to select the desired Stop Bits option 1 or 2.  |  |
| 20. | Press  to confirm your selection. SET will be displayed.  |  |
| 21. | Press  to exit Stop Bits setting routine. The SET indicator will extinguish and the  and  keys can be |  |

|  |   |  |
|--|---|--|
|  | used to select a different Comms parameter. |  |
|--|---|--|

**RS485 Address**

An RS485 network can accommodate 255 different devices, each identified by an address between 1 and 247 (Modbus™) or 1 and 255 (JC N2).

|     |  |   |
|-----|--|---|
| 22. | Use the  and  keys to select the Address option. |  |
| 23. | Press  to enter the Address setting routine. The first digit will flash.  |  |
| 24. | Use the method described in Section 4.1.2 to set the 3-digit address to the required number between 1 and 247 for Modbus™ or 1 and 255 for JC N2.  |   |

**Modbus™ Word Order (not applicable for JC N2)**

|  |   |
|--|---|
| This screen shows the word order (Hi/Lo) of the 8-bit bytes in the Modbus™ message format. Normal is Hi first. This setting cannot be changed from the front panel. (Not applicable for JC N2 format.) |  |
|--|---|





**4.7 Relay Pulse Output**



This option allows you to configure one or two optional pulse outputs from the unit. Each output can be set to provide a pulse for a defined amount of energy imported or exported. The energy monitored can be active or reactive and the pulse width can be select as 200, 100 or 60 ms. The defined energy per pulse will be the same for both outputs.

Maximum output pulse rate is two pulses per second, and the system prohibits setting of an energy-per-pulse that will give a pulse rate greater than this. For example, on a single-phase, two-wire system, a CT setting of 900A with a maximum 289V supply implies a maximum energy imported or exported in an hour of 900 x 289 = 260 kWh which is 72 W.seconds. A setting of 10Wh per pulse would generate 7 pulses per second. Since this exceeds 2/s, the unit would not allow such a setting.















Use this section to set up the relay pulse output(s) –

- Output 1** off, import kWh, export kWh, import kVArh, export kVArh
- Output 2** off, import kWh, export kWh, import kVArh, export kVArh
- Rate** (for both) 0.001/0.01/0.01/0.1/1/10/100/1000/10,000 kilo/pulse
- Pulse width** 200/100/60 ms.

|    |   |   |
|----|---|---|
| 1. | From the main Setup menu, use the  and  keys to display the Relay screen. |  |
| 2. | Press  . The Output 1 screen will appear.  |  |

From here, the  and  keys can be used to select menus for Output 1, Output 2, Rate and Pulse Width .

**Output 1**















|    |   |   |
|----|---|---|
| 3. | Use the  and  keys to select the Output 1 screen.   |  |
| 4. | Press  to enter the Output 1 setting routine. The screen will show the current setting for Output 1 flashing.  |  |
| 5. | Use the  and  keys to select the required option for Output 1: none or import/export and units.   |  |
| 6. | Press  to confirm your selection. The SET indicator will appear.   |  |
| 7. | Press  to exit Output 1 setting routine. The SET indicator will extinguish and the  and  keys can now be used to select a different Relay parameter. |  |

**Output 2**

This is the next item on the Relays menu and the method of setting is exactly the same as for Output 1















**Rate**

Use this to set the energy represented by each pulse from either output.

|     |   |   |
|-----|---|---|
| 8.  | Use the  and  keys to select the Rate screen.   |  |
| 9.  | Press  to enter the Rate setting routine. The Rate value will flash. The Rate is the energy that each output pulse represents.   |  |
| 10. | Use the  and  keys to select the Rate required for the pulse output(s).   |  |
| 11. | Press  to confirm your selection. The SET indicator will appear and the display will stop flashing.  |  |
| 12. | Press  to exit Rate setting routine. The SET indicator will extinguish and the  and  keys can be used to select a different Relay parameter. |  |

### Pulse Duration

Use this option to set the duration of pulses (in ms) from both outputs.





|     |  |   |
|-----|--|---|
| 13. | Use the  (up) and  (down) keys to select the Pulse screen.   |  |
| 14. | Press  to enter the Pulse Width setting routine. The value will flash.  |  |
| 15. | Use the  (up) and  (down) keys to select the Pulse Width in ms.  |  |
| 16. | Press  to confirm your selection. The SET indicator will appear and the display will stop flashing.   |  |
| 17. | Press  to exit Pulse Width setting routine. The SET indicator will extinguish and the  and  keys can be used to select a different Relay parameter. |  |

### 4.8 Energy Units and 1% Limit

Use this option to set the displayed units multiplier and to set a 1% limit on measured energy on or off.





The unit multiplier for all displays can be set to Wh/VArh (x1), kWh/kVArh (kilo) or MWh/MVArh (Mega).





To prevent noise from being recorded and causing 'meter creep', a 1% limit can be imposed on the measured input such that readings less than 1% of maximum are not recorded. This limit can be turned off so that even small energy increments are recorded.

|    |   |   |
|----|---|---|
| 1. | Use the  and  keys to select the Energy screen. |  |
| 2. | Press  to select the Energy menu.  |  |















At this stage, you can use the  and  keys to select either the **Energy Units** or **1% Limit** menu.

### Energy Units

|    |  |   |
|----|--|---|
| 3. | With the Unit screen selected, press  to enter the Units setting routine. The currently selected unit flashes.                      |  |
| 4. | Use the  and  keys to select the required units. |  |













|    |  |   |
|----|--|---|
| 5. | Press  to confirm your selection. The SET indicator will appear and the display will stop flashing. |  |
| 6. | Press  to exit Units setting routine. The SET indicator will extinguish.                            |  |

**1% Limit**

|     |  |   |
|-----|--|---|
| 7.  | Use the  and  keys to select the Limit screen.   |    |
| 8.  | Press  to enter the Limit setting routine. The value will flash.  |    |
| 9.  | Use the  and  keys to turn the 1% limit on or off. With Limit On, line noise below 1% of the maximum range will not be recorded. |    |
| 10. | Press  to confirm your selection. The SET indicator will appear and the display will stop flashing.  |   |
| 11. | Press  to exit 1% Limit setting routine. The SET indicator will extinguish.   |  |
| 12. | Press  again to exit the Limit menu and return to the main Setup menu.  |  |

**4.9 Test**

This option provides various test facilities.

|   |   |   |
|---|---|---|
| 1.  | Use the  and  keys to select the Test screen.   |  |
| 2.  | Press  to enter the Test menu.   |  |
| 3.  | Use the  and  keys to select the required test option and press  to confirm your selection. The available options are: |  |
|  | Lights all LED segments so that display segments can be checked.  |  |
|  | Toggles display segments alternately.   |   |



|    |  |  |
|----|--|--|
|    | Shows the voltage and current phase sequences. |  |
| 4. | Press  to exit the selected test display mode. |  |
| 5. | Press  again to return to the main Setup menu. |  |

The voltage and current inputs must be greater than 5% of nominal for the test to operate reliably.

Voltage and current phase displays show the phase relationships of the inputs. To obtain the correct power readings, the phase sequences can be either '123' or '132' but must be the same for both current and voltage.

To obtain phase indications, the measured phase relationships must be within the following parameters. If, for instance, a current transformer were to be reverse connected, the phase of the measured current for that phase would be out by 180° and the display would indicate a current phase error.

### Three-phase four-wire mode

Measurements are referenced from L1.

#### Voltage:

For the voltage sequence test, the phase of L2 relative to L1 must be within the window  $240^\circ \pm 48^\circ$  and L3 relative to L1 must be within the window  $120^\circ \pm 48^\circ$  to record the sequence V123.

Alternatively, the phase of L2 relative to L1 must be within the window  $120^\circ \pm 48^\circ$  and L3 relative to L1 must be within the window  $240^\circ \pm 48^\circ$  to record the sequence V132.

The display shows 'V1--' if a voltage phase is outside these parameters.

#### Current:

For the current sequence test, the phase of I1 relative to L1 must be within the window  $0^\circ \pm 48^\circ$ , I2 relative to L1 must be within the window  $240^\circ \pm 48^\circ$ , and I3 relative to L1 must be within the window  $120^\circ \pm 48^\circ$  to record the sequence i123.

Alternatively the phase of I1 relative to L1 must be within the window  $0^\circ \pm 48^\circ$ , I2 relative to L1 must be within the window  $120^\circ \pm 48^\circ$ , and I3 relative to L1 must be within the window  $240^\circ \pm 48^\circ$  to record the sequence i132.

The display shows 'I --' if a current phase is outside these parameters.

### Three-phase three-wire mode

Measurements are referenced from L1-L2.

#### Voltage:

For the voltage sequence test, the phase of L2-L3 relative to L1-L2 must be within the window  $240^\circ \pm 48^\circ$  and L3-L1 relative to L1-L2 must be within the window  $120^\circ \pm 48^\circ$  to record the sequence V123.

Alternatively, the phase of L2-L3 relative to L1-L2 must be within the window  $120^\circ \pm 48^\circ$  and L3 relative to L1-L2 must be within the window  $240^\circ \pm 48^\circ$  to record the sequence V132.

The display shows 'V1--' if a voltage phase is outside these parameters.

#### Current:

For the current sequence test, the phase of I1 relative to L1-L2 must be within the window  $330^\circ \pm 48^\circ$ , I2 relative to L1-L2 must be within the window  $210^\circ \pm 48^\circ$ , and I3 relative to L1-L2 must be within the window  $90^\circ \pm 48^\circ$  to record the sequence i123.

Alternatively, the phase of I1 relative to L1-L2 must be within the window  $330^\circ \pm 48^\circ$ , I2 relative to L1-L2 must be within the window  $90^\circ \pm 48^\circ$ , and I3 relative to L1-L2 must be within the window  $210^\circ \pm 48^\circ$  to record the sequence i132.

The display shows 'I --' if a current phase is outside these parameters.

## 4.10 Version Information

The last two options of the Set-up menu show the versions of firmware and hardware of the unit.

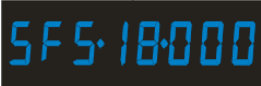
A digital display showing the text "SF5.18.000" in blue characters on a black background.

Shows build number, e.g. 18.000

A digital display showing the text "SFH.1.020" in blue characters on a black background.

Shows firmware version, e.g. 1.020.

## 5 Specification

### 5.1 Measurement Inputs.

3-Phase 4-Wire, 3-Phase 3-Wire and Single-Phase 2-Wire Unbalanced.

Direct measurement of 173 to 500Vac L-L, (100 to 289Vac L-N).

Line frequency measured from L1 voltage or L3 voltage.

Three current inputs (six physical terminals) for connection of external CTs.

#### 5.1.1 Range of Use

Values of measured quantities, components of measured quantities, and quantities which affect measurement errors to some degree, for which the product gives meaningful readings.

|                |   |
|----------------|---|
| Voltage        | 5 ... 120% of Range Maximum (below 5% of Range Maximum voltage, current indication may only be approximate) |
| Current        | 1 ... 120% of nominal   |
| Active power   | 1 ... 144% of nominal, 360MW maximum  |
| Apparent power | 1 ... 144% of nominal, 360MVA maximum   |

Power is only registered when voltage and current are within their respective range of use.

### 5.2 Accuracy

|   |  |
|---|--|
| Active energy (Wh)  | Class 1 IEC 62053-21   |
| Reactive energy (VARh)  | 1% of Range Maximum  |
| Temperature co-efficient  | Active energy = 0.018%/°C, typical   |
| Error change due to variation of an influence quantity in the manner described in Section 6 of IEC 688:1992 | 2 × error allowed for the reference condition applied in the test. Error due to temperature variation as above.  |
| Error in measurement when a measurand is within its measuring range, but outside its reference range        | 2 × error allowed at the end of the reference range adjacent to the section of the measuring range, where the measurand is currently operating / being tested. |

### 5.3 Auxiliary Supply

The unit can be powered from an auxiliary a.c. or d.c. supply that is separate from the metered supply. Two-way fixed connector with 2.5mm<sup>2</sup> stranded wire capacity.

110 to 400V a.c. 50/60Hz ±10% or 120V to 350V d.c. ±20%. Consumption < 5VA.

## 5.4 Option Modules

Two option modules can be fitted which can be of two types: a single RS485 (Modbus™ / JC N2) or single pulse relay output. A fully populated product can support one RS-485 channel and one pulse relay output or two pulse relay outputs.

### 5.4.1 Pulse Relay Outputs

These outputs can be configured from the Set-up menu.

Each of the two possible outputs can be set to generate pulses representing imported kWh, exported kWh, imported kVArh, or exported kVArh.

**Rate** can be set to generate 1 pulse per

|       |                 |
|-------|-----------------|
| 0.001 | = 1 Wh/VArh     |
| 0.01  | = 10 Wh/VArh    |
| 0.1   | = 100 Wh/VArh   |
| 1     | = 1 kWh/kVArh   |
| 10    | = 10 kWh/kVArh  |
| 100   | = 100 kWh/kVArh |
| 1000  | = 1 MWh/MVArh   |
| 10000 | = 10 MWh/MVArh  |

The rate cannot be set to a value that could result in more than 2 pulses/second.

**Pulse width** 200/100/60 ms.

### 5.4.2 RS485 Output for Modbus™ or JC N2 Protocol

For Modbus™, the following RS485 communication parameters can be configured from the Set-up menu.

Baud rate 2400, 4800, 9600, 19200, 38400

Parity none/odd/even

Stop bits 1 or 2

RS485 network address *nnn* – 3-digit number 1 to 247

Modbus™ Word order – Hi/Lo byte order is set automatically to normal or reverse.

Only 1 stop bit can be set if odd or even parity is required.

For JC N2, only the RS485 network address can be configured. The range of addresses is 1-255.

## 5.5 Reference Conditions of Influence Quantities

Influence Quantities are variables that affect measurement errors to a minor degree. Accuracy is verified under nominal value (within the specified tolerance) of these conditions.

|                                   |  |
|-----------------------------------|--|
| Ambient temperature               | 23°C ±1°C                              |
| Input waveform                    | 50 or 60Hz ±2%                         |
| Input waveform                    | Sinusoidal (distortion factor < 0.005) |
| Auxiliary supply voltage          | Nominal ±1%                            |
| Auxiliary supply frequency        | Nominal ±1%                            |
| Auxiliary supply waveform (if AC) | Sinusoidal (distortion factor < 0.05)  |
| Magnetic field of external origin | Terrestrial flux                       |

## 5.6 Environment

|                       |                                 |
|-----------------------|---------------------------------|
| Operating temperature | -10°C to +55°C*                 |
| Storage temperature   | -20°C to +70°C*                 |
| Relative humidity     | 0 to 90%, non-condensing        |
| Altitude              | Up to 2000m                     |
| Warm up time          | 1 minute                        |
| Vibration             | 10Hz to 50Hz, IEC 60068-2-6, 2g |
| Shock                 | 30g in 3 planes                 |

\*Maximum operating and storage temperatures are in the context of typical daily and seasonal variation.

## 5.7 Mechanics

|                                     |   |
|-------------------------------------|---|
| Dimensions                          | 96 × 96 mm (L×W)                          |
| Depth (behind panel)                | 53 mm, 77.5mm with option module(s)       |
| Case protrusion (in front of panel) | 7 mm maximum                              |
| Sealing                             | IP52 (front panel), IP30 (case) (minimum) |
| Mounting                            | DIN 96 panel mounting                     |

## 5.8 Approval, Certification, and Standards Compliance

RoHS compliant. (Although this class of product is presently excluded from the RoHS regulations, the unit has been designed and manufactured in compliance with the RoHS regulations.)

### EMC Conducted and Radiated Emissions

BS EN 61326, Class A (Industrial)

### EMC Immunity

BS EN 61326, Class A (Industrial)

### Safety

BS EN 61010-1:2001

## 6 Maintenance

In normal use, little maintenance is needed. As appropriate for service conditions, isolate electrical power, inspect the unit and remove any dust or other foreign material present. Periodically check all connections for freedom from corrosion and screw tightness, particularly if vibration is present.

The front of the case should be wiped with a dry cloth only. Use minimal pressure, especially over the viewing window area. If necessary wipe the rear case with a dry cloth. If a cleaning agent is necessary, isopropyl alcohol is the only recommended agent and should be used sparingly. Water should not be used. If the rear case exterior or terminals should be contaminated accidentally with water, the unit must be thoroughly dried before further service. Should it be suspected that water might have entered the unit, factory inspection and refurbishment is recommended.

In the unlikely event of a repair being necessary, it is recommended that the unit be returned to the factory or nearest Crompton Instruments / Tyco Electronics service centre.

## 7 Installation

The unit may be mounted in a panel of any thickness up to a maximum of 6 mm (0.25in). Leave enough space behind the instrument to allow for bends in the connection cables. As the front of panel enclosure conforms to IP52, it is protected from dripping water. The unit is intended for use in a reasonably stable ambient temperature within the range -10 to +55°C. Do not mount the unit where there is excessive vibration or in excessive direct sunlight.

Warning  

- **During normal operation, voltages hazardous to life may be present at some of the terminals of this unit. Installation and servicing should be performed only by qualified, properly trained personnel abiding by local regulations. Ensure all supplies are de-energised before attempting connection or other procedures.**
- **This product relies on its Protective Earth connection, made through the CT terminal block, for safety. As such, under no circumstances should this product be operated without a Protective Earth connection.**
- **Terminals should not be user accessible after installation and external installation provisions must be sufficient to prevent hazards under fault conditions.**
- **This unit is not intended to function as part of a system providing the sole means of fault protection – good engineering practice dictates that any critical function be protected by at least two independent and diverse means.**
- **The unit does not have internal fuses therefore external fuses must be used for protection and safety under fault conditions.**
- **Never open-circuit the secondary winding of an energized current transformer.**
- **If this equipment is used in a manner not specified by the manufacturer, protection provided by the equipment may be impaired.**

### 7.1 Safety

The unit is designed in accordance with BS EN 61010-1:2001 (IEC 61010-1:2001) – Permanently connected use, Normal condition. Installation category III, pollution degree 2, basic insulation for rated voltage. Measurement Category III.

## 7.2 EMC Installation Requirements

Whilst this unit complies with all relevant EU EMC (electro-magnetic compatibility) regulations, any additional precautions necessary to provide proper operation of this and adjacent equipment will be installation dependent and so the following can only be general guidance:

- Avoid routing wiring to this unit alongside cables and products that are, or could be, a source of interference.
- The auxiliary supply to the unit should not be subject to excessive interference. In some cases, a supply line filter may be required.
- To protect the product against incorrect operation or permanent damage, surge transients must be controlled. It is good EMC practice to suppress transients and surges at the source. The unit has been designed to automatically recover from typical transients; however in extreme circumstances it may be necessary to temporarily disconnect the auxiliary supply for a period of greater than 10 seconds to restore correct operation.
- Screened communication leads are recommended and may be required. These and other connecting leads may require the fitting of RF suppression components, such as ferrite absorbers, line filters etc., if RF fields cause problems.
- It is good practice to install sensitive electronic instruments that are performing critical functions in EMC enclosures that protect against electrical interference causing a disturbance in function.

### 7.3 Case Dimensions and Panel Cut-Out

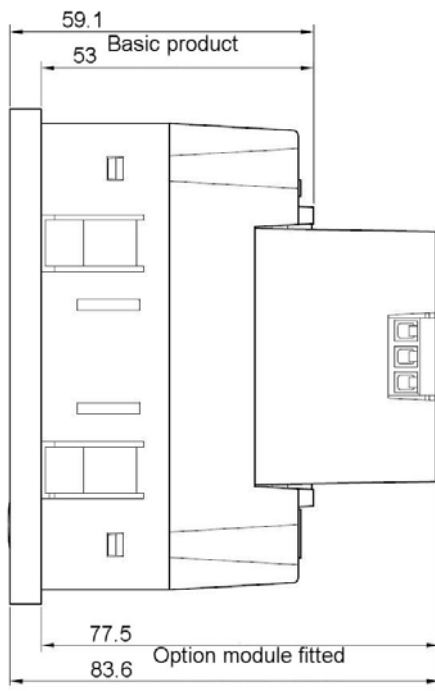
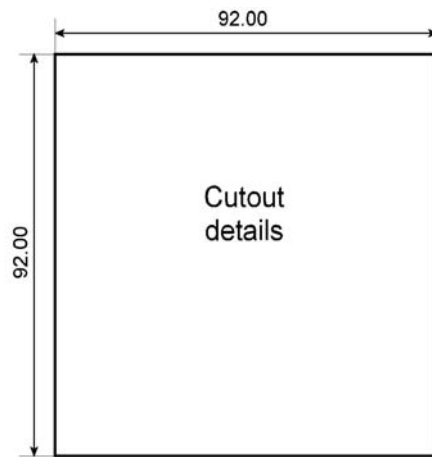

Side view

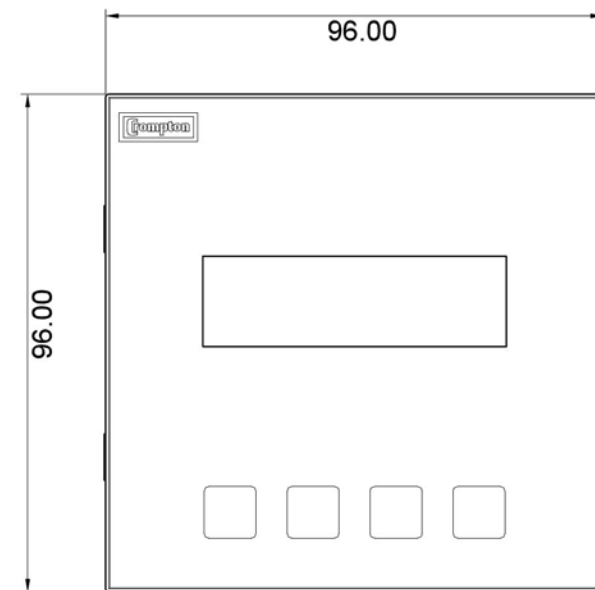

Front view



## 7.4 Wiring

Input connections are made to screw clamp terminals. Choice of cable should meet local regulations.

**The current inputs of these products are designed for connection into systems via current transformers only.**

To minimise measurement errors, the CTs should be grounded as shown in the wiring diagram in Section 7.9.

CT secondaries must be grounded in accordance with local regulations. It is desirable to make provision for shorting links to be made across CTs to permit easy replacement of a unit should this ever be necessary.

All negative current inputs are commoned inside the unit and grounding should be at one point only.

## 7.5 Additional considerations for three wire systems

The neutral terminal (terminal N) is indirectly connected to the voltage input terminals (terminals L1, L2, L3). When connected to a three wire system the neutral terminal will adopt a potential somewhere between the remaining lines. If external wiring is connected to the neutral terminal it must be connected to either the neutral line or earth (ground) to avoid the possibility of electric shock from the neutral terminal.

## 7.6 Auxiliary Supply

The Integra Ci1 should ideally be powered from a dedicated supply. However, it may be powered from the signal source providing the source remains within tolerance for the auxiliary supply.

The unit can be powered from an auxiliary a.c. or d.c. supply that is separate from the metered supply.

110 to 400V a.c. 50/60Hz  $\pm 10\%$  or 120V to 350V d.c.  $\pm 20\%$ . Consumption < 5VA.

## 7.7 Fusing

This unit must be fitted with external fuses in voltage and auxiliary supply lines. Voltage input lines must be fused with a quick blow fuse 1A maximum. Auxiliary supply lines must be fused with a slow blow fuse rated 1A maximum. Choose fuses of a type and with a breaking capacity appropriate to the supply and in accordance with local regulations.

A switch or circuit breaker allowing isolation of supplies to the unit must be provided.

## 7.8 Earth/Ground Connections

For safety reasons, current transformer secondary connections should be grounded in accordance with local regulations. The unit relies on this ground connection as a Protective Earth. As such, under no circumstances should the product be operated without a Protective Earth connection.

### 7.9 Connection Diagrams

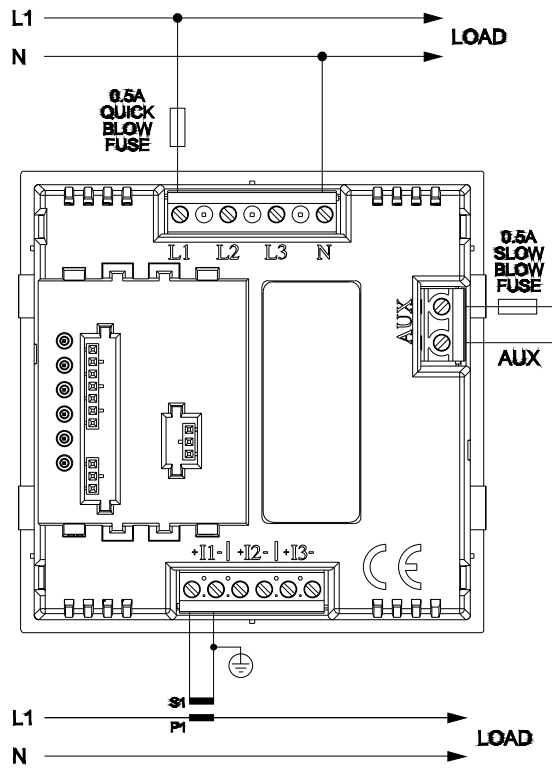

Single phase

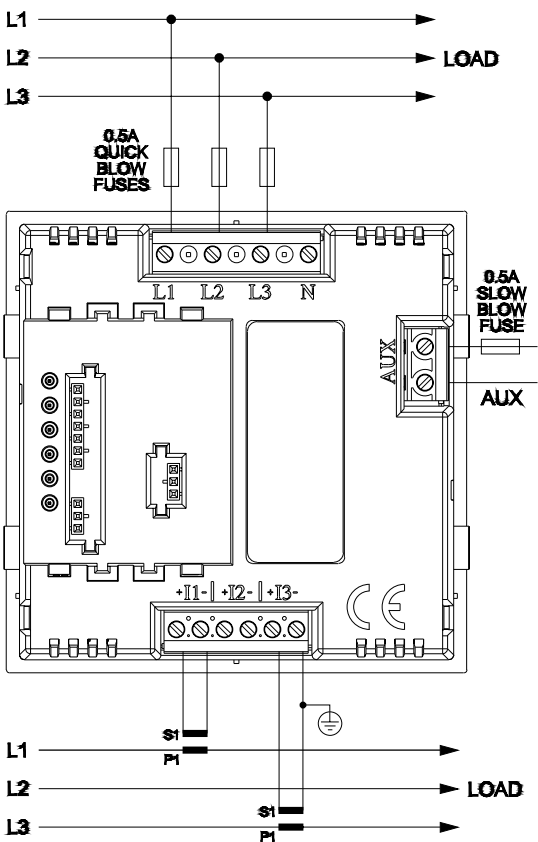

3-phase 3-wire

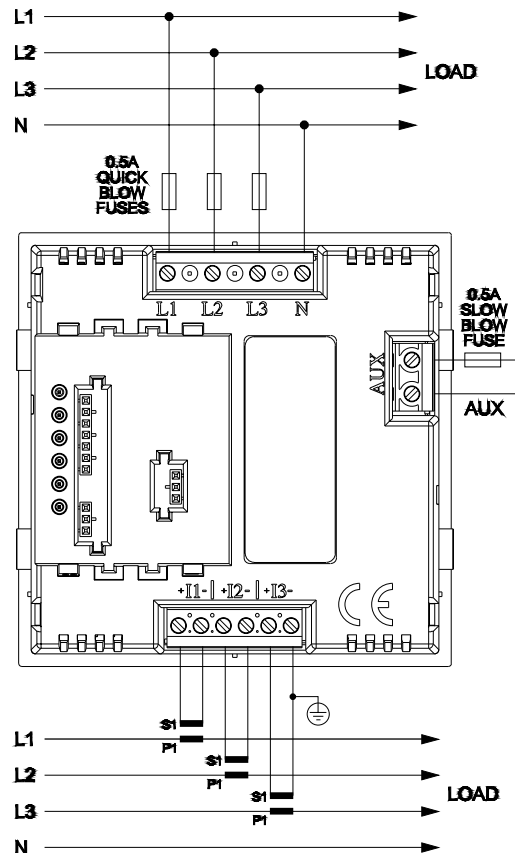

3-phase 4-wire

## 7.10 RS485 and Modbus™ or JC N2 Protocol

An optional RS485 module can be plugged into the rear of the Integra Ci1. RS485 in conjunction with the Modbus™ or JC N2 protocol allow the unit to be interrogated and provide a response detailing the readings it has taken. This can be used for remote monitoring by a PC or SCADA system.

An RS485 and Modbus™ Protocol Guide is available for download from the Crompton Instruments web site at <http://www.crompton-instruments.com/datasheets/ci-communication-guide.pdf>

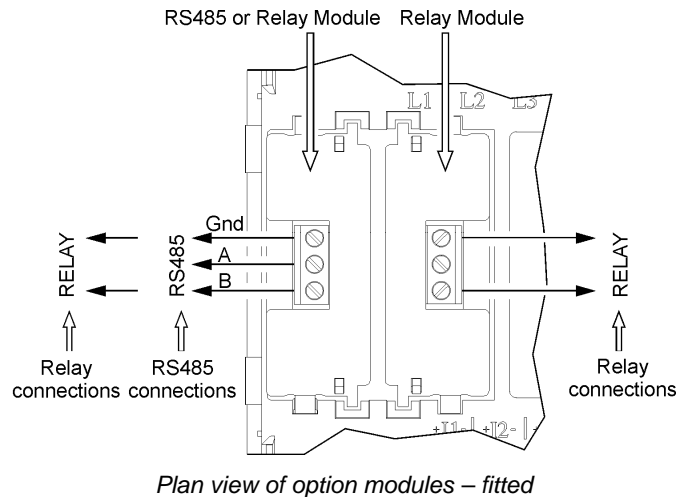

## 7.11 Operation Check

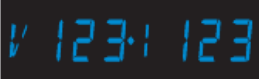
After installation, use the test display  to check for incorrect wiring of the voltage and current transformer inputs. The displayed voltage (V) and current (I) sequences must be the same but can be '123' or '132'.

In the event of a voltage phase error, e.g. the same phase connected to two meter inputs, the display will show 'V1--'.

In the event of a current phase error, e.g. a current transformer reverse connected or connected to the wrong phase, the display will read 'I --'.

If the display shows an identical V and I sequence (123 or 132), check that the meter gives the correct forward and reverse indications. An incorrect forward/reverse indication means that all current transformer connections are reversed.

The meter has a defined tolerance for displaying phasing errors, see Section 4.9.

## 8 Glossary

|                          |  |
|--------------------------|--|
| Active energy            | Accumulated energy (Watt hours).   |
| CT                       | Current Transformer. Transforms a (usually) high current to a value that can be monitored by the meter.  |
| Firmware                 | Software installed on a permanent medium.  |
| Johnson Controls (JC) N2 | A master - slave serial communication protocol with fixed communication parameters.  |
| Modbus™                  | A proprietary communications protocol used for control and monitoring.   |
| Reactive energy          | The energy (VARh) in the reactive component of the supply. The current and voltage in the reactive component are mutually 90° out of phase - capacitive or inductive – resulting in a supply power factor of zero. |
| RS485                    | A serial communication system linking multiple addressed terminals.  |
| SCADA                    | Supervisory Control And Data Acquisition system.   |

## 9 Index

- 1% limit, 16, 17
- Address, 13, 21
- Auxiliary supply, 20, 26
- Baud rate, 11, 21
- Blue man, 6
- Certification, 22
- Connections, 26
- CT, 5, 10
- CT earth, 26
- CT primary current, 5, 6, 10
- Current transformer, 5, 10, 26
- Displayed units, 16
- Divisors, 14
- EMC, 22, 24
- Error, 20
- Firmware version, 6, 19
- Fuses, 26
- Hardware version, 19
- Inputs, 20
- JC N2, 5, 11
- Johnson Controls, 5, 11
- LED check, 17
- Limit, 16, 17
- Maintenance, 23
- Meter creep, 16
- Meter current, 10
- Modbus™, 5, 11, 21, 28
- Multiplier, 16
- Noise, 16
- Number entry, 8
- Option modules, 21
- Parity, 12, 21
- Password, 9
- Phase sequence, 18
- Protective Earth, 23, 24, 26
- Pulse duration, 16
- Pulse output, 5, 6, 13, 21
- Pulse rate, 13, 14
- Pulse width, 13, 16, 21
- Range maximum, 20
- Relay output 1, 14
- Relay output 2, 14
- Reset energy, 10
- RoHS, 22
- RS485, 5, 21, 28
- RS485 address, 13
- Safety, 24
- Screen check, 6
- SET indicator, 8
- Size, 22, 25
- Standards, 22
- Start Up Screens, 6
- Stop bits, 12, 21
- Supply selection, 9
- Temperature, 21, 24
- Test, 6, 17
- Units, 16
- Version, 19

Tyco Electronics, the TE logo and INTEGRA are trademarks. CROMPTON is a trademark of Crompton Parkinson Ltd. and is used by Tyco Electronics under license. Other Trademarks or company names mentioned herein are the property of their respective owners.

All of the above information, including drawings, illustrations and graphic design, reflects our present understanding and is to the best of our knowledge and belief correct and reliable. Users, however, should independently evaluate the suitability of each product for the desired application. Under no circumstances does this constitute an assurance of any particular quality or performance. Such an assurance is only provided in the context of our product specifications or explicit contractual arrangements. Our liability for these products is set forth in our standard terms and conditions of sale.

Tyco Electronics UK Ltd

Crompton Instruments  
Freebournes Road, Witham  
Essex CM8 3AH  
England

Tel: +44 (0) 1376 509509  
Fax: +44 (0) 1376 509511  
[www.crompton-instruments.com](http://www.crompton-instruments.com)