

Installation and Operating Instructions

549 AC Ammeter

AC ammeter for measuring single phase current.



Introduction

The 549 Digital Ammeter is designed to accurately measure AC RMS Current via a Current transformer. Measurements will be displayed on an integral LCD. The compact design allows it to be fitted in a standard 17/32 inch switch knock out. The product harvests power from the input signal. No other power supply is required to power this product.

This manual provides all the necessary instructions to safely install and operate the instrument.

Front Panel Buttons

In measurement mode, the buttons control the displayed measurement as follows:



	Screen navigation In set-up mode, this is the 'Next' button.
	Changes the highlighted value (set-up mode only)



Setting up

The instrument has a default CT ratio setting of 5:5A. Before operation the product MUST be set to the correct CT ratio.

The instrument is fitted with an internal battery which has a limited life expectancy as it is only designed for commissioning purposes, when battery powered pressing two buttons simultaneously enters "Setup" mode. The Instrument will automatically switch off after approximately 10 seconds of inactivity. The battery supplies the programming function and does not affect the overall operation of the instrument. If the battery does become exhausted the setup mode can still be accessed by passing a current between 10-100% of nominal through the product.







- Press and hold the two buttons  and  simultaneously (for five seconds if not battery powered) until the CT Ratio screen is displayed.



- Press the  button to enter CT ratio, edit mode. The figure furthest left on the display will flash, use the  button to change value of this digit, to the desired value then use the  button to move to the next digit. Repeat this action for all the digits until the correct primary current of the CT has been selected.

- After making changes to the last digit press the  again, now all the primary current 4 digits will flash at the same time.



- Press the  button again to confirm the value and the display screen will show the word 'SET'. This indicates that the value has been stored in the product. Press the  button again to exit "edit mode", the currently selected primary CT value will be displayed.
- To exit the Set-Up mode press both  and  buttons and the instrument will return to the measuring screen.

Setup Menu Structure

- Press and hold the two buttons  and  simultaneously (for approximately 10 seconds if not battery powered) until the CT Ratio screen is displayed.

CT Ratio



- Press the  again, to move to the next screen in the menu.

Model Number

- Press the  again, to move to the next screen in the menu.



- You cannot edit this screen



Serial Number (HEX)

- Press the  again, to move to the next screen in the menu.
- You cannot edit this screen

Version Number





- Press the  again, to move to the next screen in the menu.
- You cannot edit this screen

Segment Test



- Press the  again, to move to the next screen in the menu.
- You cannot edit this screen

- To exit the Set-Up mode, either press both  and  buttons (for approximately 10 seconds if not battery powered) and instrument will return to the measuring screen automatically.



- If the product is being setup under battery power then the LO screen may appear briefly as the product returns to measurement mode. Before the battery power is disconnected.

Installation

The unit may be mounted in a panel of any thickness up to a maximum of 6mm (0.25in). Leave enough space behind the instrument to allow for bends in the connection cables. As the front of panel enclosure conforms to IP52, it is protected from dripping water. The unit is intended for use in a reasonably stable ambient temperature within the range -10 to +55°C. Do not mount the unit where there is excessive vibration or in excessive direct sunlight.

Safety

The unit is designed in accordance with BS EN 61010-1:2001 (IEC 61010-1:2001) – Permanently connected use, Normal condition. Installation category III, pollution degree 2, basic insulation for rated voltage. Measurement Category III.

EMC Installation Requirements

Whilst this unit complies with all relevant US EMC (electromagnetic compatibility) regulations, any additional precautions necessary to provide proper operation of this and adjacent equipment will be installation dependent and so the following can only be general guidance:

- Avoid routing wiring to this unit alongside cables and products that are, or could be, a source of interference.
- The signal to the unit should not be subject to excessive interference. In some cases, a supply line filter may be required.
- To protect the product against incorrect operation or permanent damage, surge transients must be controlled. It is good EMC practice to suppress transients and surges at the source. The unit has been designed to automatically recover from typical transients; however in extreme circumstances it may be necessary to temporarily reduce the magnitude of the measured signal to the point where the instrument turns off for a period of greater than 10 seconds to restore correct operation.
- It is good practice to install sensitive electronic instruments that are performing critical functions in EMC enclosures that protect against electrical interference causing a disturbance in function.

Wiring

Input connections are made to terminals posts. Use cable lugs suitable for 6-32 UNC screw. Wiring should conform to national Electrical Code Class 1 and sized appropriate to CT secondary current ratings.

The current inputs of this product are designed for connection into systems via current transformers only. Instrument transformers used for connection to the meter must be of approved type and compliant with ANSI/IEEE C57.13 or IEC 60044-1, selected and sized appropriate to the supply network being monitored. CT secondaries must be grounded in accordance with local regulations. It is desirable to make provision for shorting links to be made across CT secondary's to permit easy replacement of a unit should this ever be necessary.

This instrument is intended for panel mounting. Terminals must be enclosed within the panel. Terminal nuts should be tightened to 8.0 lbs in (1.0Nm) only.

Earth/Ground Connections

For safety reasons, current transformer secondary connections should be grounded in accordance with local regulations. Under no circumstances should the product be operated without this Earth connection.

Maintenance

In normal use, little maintenance is needed. As appropriate for service conditions, isolate from electrical power, inspect the unit,

Warnings



Caution: Risk of Electric Shock

- During normal operation, voltages hazardous to life may be present at some of the terminals of this unit.
- Installation and servicing should be performed only by qualified, properly trained personnel abiding by local regulations.
- Ensure all supplies are de-energised before attempting connection or other procedures.
- Terminals should not be user accessible after installation and external installation provisions must be sufficient to prevent hazards under fault conditions.
- Never open-circuit the secondary winding of an energized current transformer.
- This product should only be operated with CT secondary connections Earthed.
- If this equipment is used in a manner not specified by the manufacturer, protection provided by the equipment may be impaired.
- If sufficient torque setting of 8.0lbs in (1.0Nm) cannot be applied to the rear fixing, the product should not be installed.

and remove any dust or other foreign material present. Periodically check all connections for freedom from corrosion and screw tightness, particularly if vibration is present.

The front of the case should be wiped with a dry cloth only. Use minimal pressure, especially over the viewing window area. If necessary wipe the rear case with a dry cloth. If a cleaning agent is necessary, isopropyl alcohol is the only recommended agent and should be used sparingly. Water should not be used. If the rear case exterior or terminals should be contaminated accidentally with water, the unit must be thoroughly dried before further service. Should it be suspected that water might have entered the unit, factory inspection and refurbishment is recommended.

Contains no serviceable parts:

In the unlikely event of a repair being necessary, it is recommended that the unit be returned to the factory or nearest Crompton Instruments / TE Connectivity service centre.

This product contains a Lithium cell, and should be recycled or disposed of in accordance with local environmental regulations.

Specification

Measurement Inputs

Nominal Input Current	5A AC RMS
Max. Continuous input Overload	6A AC RMS
Max. Short duration input Current	50A for 1 second.
Maximum VA Burden	3 VA
Frequency	60Hz +/- 2%
Maximum Total Harmonic Distortion	30%
Maximum Crest Factor	1.68

Range of Use

Values of measured quantities, components of measured quantities, and quantities which affect measurement errors to some degree, for which the product gives meaningful readings:

Current	1 ... 120% of nominal
Ratio	5 ... 2000A

Accuracy

Current (A)	± 1% of range
-------------	---------------

Reference Conditions of Influence Quantities

Influence Quantities are variables that affect measurement errors to a minor degree. Accuracy is verified under nominal value (within the specified tolerance) of these conditions.

Ambient temperature	23°C ±2°C
Input waveform	60Hz ± 0.5%
Input waveform	Sinusoidal (distortion factor <0.005)
Magnetic field of external origin	Terrestrial flux

Environment

Operating temperature	-10°C to +55°C *
Storage temperature	-30°C to +85°C *
*Maximum operating and storage temperatures are in the context of typical daily and seasonal variation.	
Relative humidity	0 to 95%, non-condensing
Altitude	Up to 2000m
Vibration	10Hz to 50Hz, IEC 60068-2-6, 2g
Shock	30g in 3 planes

Mechanics

Dimensions	40.80x47.25x59.25mm (h x w x d) 1.60"x 1.86"x2.33" (h x w x d)
Depth (behind panel)	2.36" (60 mm) maximum
Case protrusion (front of panel)	0.48" (12.2 mm) maximum
Sealing	IP52 (front panel), IP30 (case) (minimum)

Approval, Certification, and Standards Compliance

EMC, Emissions	FCC Part 15
Safety	UL 61010-1:2 nd edition.

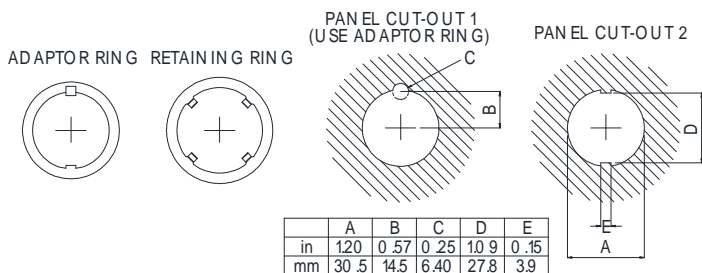
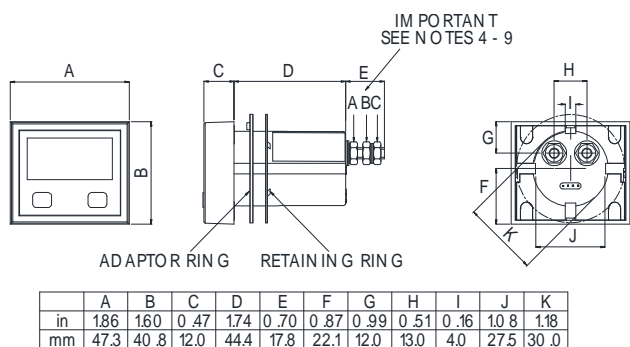

GUIDE NOTES FOR USING SUPPLIED FITTING KIT.

- 1) PLACE INSTRUMENT IN PANEL CUTOUT.
- 2) FIT ADAPTOR RING, IF USING CUTOUT 1.
- 3) FIT RETAINING RING, ENSURING TABS ARE ALIGNED AS SHOWN. (APPROX 45 DEGREE ANGLE RELATIVE TO GROOVES IN CASE)
- 4) IMPORTANT - NUT 'A' IS USED FOR FACTORY ASSEMBLY ONLY AND MUST NOT BE TAMPERED WITH DURING INSTALLATION.
- 5) FIT NUT 'B', ENSURING A NOM 3mm GAP IS LEFT BETWEEN IT AND NUT 'A'
- 6) FIT WASHERS PRIOR TO AND AFTER CONNECTION WIRES.
- 7) FIT NUT 'C'.
- 8) ENSURE NUT 'B' IS REFRAINED FROM MOVEMENT.
- 9) NUT 'C' SHOULD NOW BE TIGHTENED.

Connection Diagram

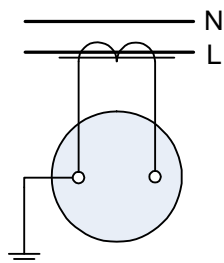

While TE Connectivity (TE) has made every reasonable effort to ensure the accuracy of the information in this catalogue, TE does not guarantee that it is error-free, nor does TE make any other representation, warranty or guarantee that the information is accurate, correct, reliable or current. TE reserves the right to make any adjustments to the information contained herein at any time without notice. TE expressly disclaims all implied warranties regarding the information contained herein, including, but not limited to, any implied warranties of merchantability or fitness for a particular purpose. The dimensions in this catalogue are for reference purposes only and are subject to change without notice. Specifications are subject to change without notice. Consult TE for the latest dimensions and design specifications. TE Connectivity and TE connectivity (logo) are trademarks. CROMPTON is a trademark of Crompton Parkinson Limited and is used under licence. Other products or company names mentioned herein may be trademarks of their respective owners.



Tyco Electronics UK Ltd
A TE Connectivity company
Freebournes Road,
Witham, CM8 3AH, UK
Tel: +44 (0) 1376 509509
Fax: +44 (0) 1376 509511
www.crompton-instruments.com
www.energy.te.com

Registered office:
Faraday Road, Dorcan
Swindon, SN3 5HH
Reg. No. 550 926