

**Application:**  
Relaying

**Frequency:**  
50 - 400Hz

**Insulation Level:**  
600 Volts, 10kV BIL full wave

**Continuous Thermal Current Rating Factor:**  
See TRF at curve

- Terminals are brass studs No. 8 - 32 with one flat washer, lockwasher and regular nut
- The transformer winding is arranged so that the turns are fully distributed between all taps
- Order mounting bracket kit separately
- Approximate weight: 13 lbs

Approvals



# Model 117MR

**Window Diameter 4.62"**

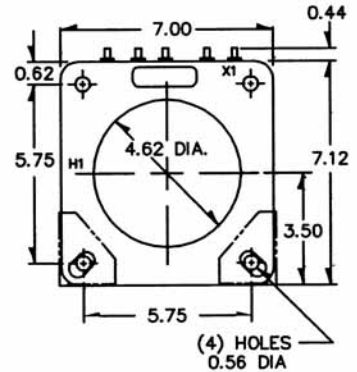
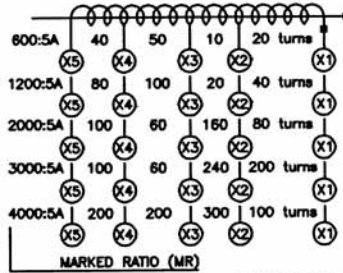
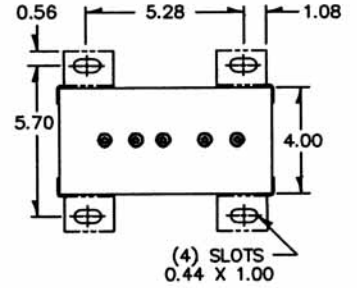
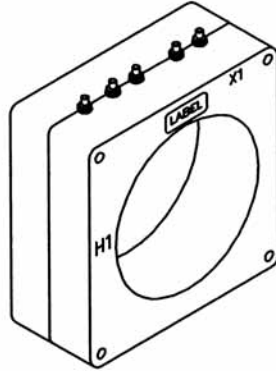

EXCITATION CURVE

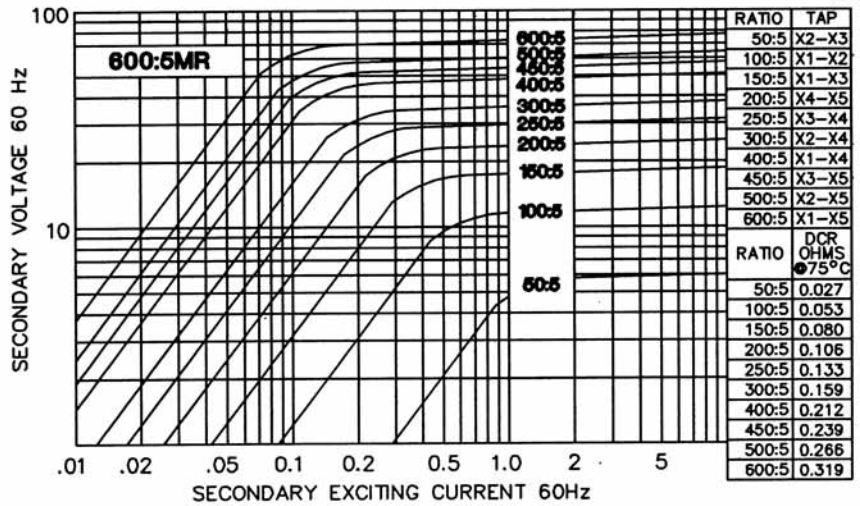

Model 117-601MR - rating C20

TRF= 2.0 @ 30°C, 1.5 @ 55°C amb.

# Model 117 - 122MR

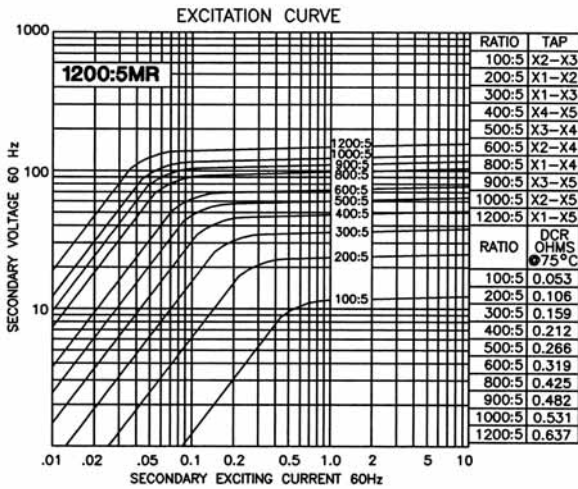

**Model 117-202MR - rating C100**

TRF= 1.33 ● 30°C, 1.0 ● 55°C amb.

# Model 117 - 202MR

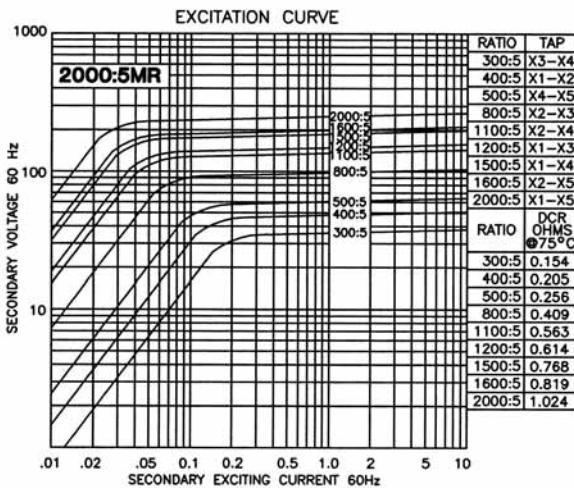

**Model 117-202MR - rating C100**

TRF= 1.00 ● 30°C, 0.6 ● 55°C amb.